

PAL 10mm ANGLE BEAD
PAL DIE No 5097

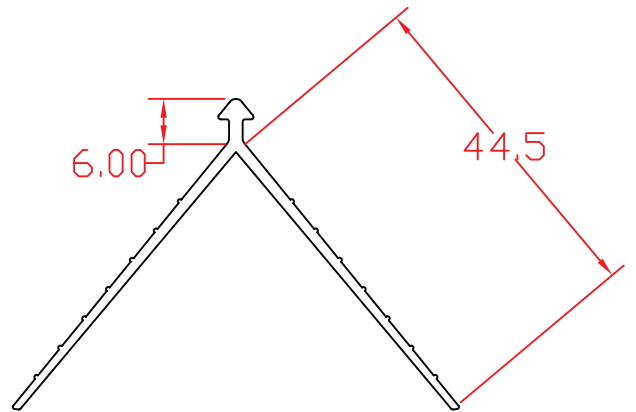

PAL 6mm ANGLE BEAD
PAL DIE No 5096

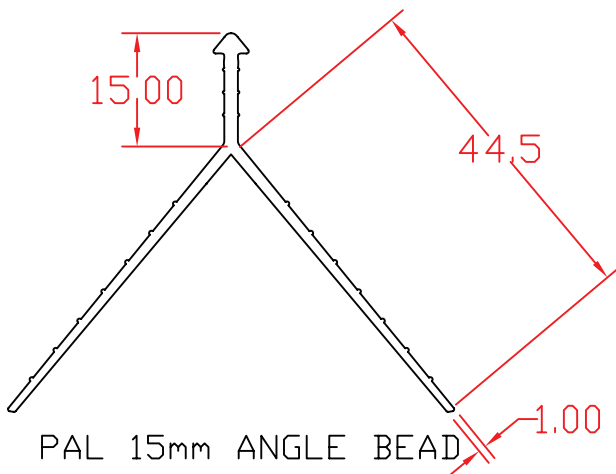

PAL 15mm ANGLE BEAD
PAL DIE No 5098

Side View

holes punched
as shown

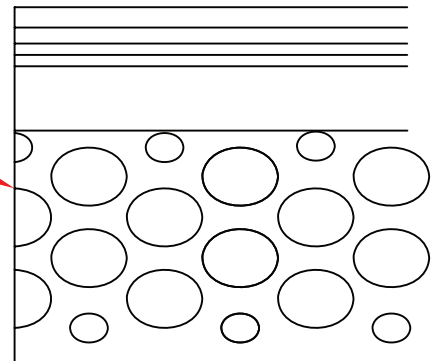

A4

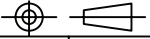
MATERIAL:	COLOUR:	ALL DIMENSIONS IN MM				
		PROJECTION 				
TITLE:	DRAWING No.	ISSUE:	DRAWN:	INITIAL:	DATE:	SCALE:
ANGLE BEADS		1	8/01/09	MR		
PAL EXTRUSIONS DARLASTON ROAD WEDNESBURY WS10 7TN TEL: 0121 526 4048						©

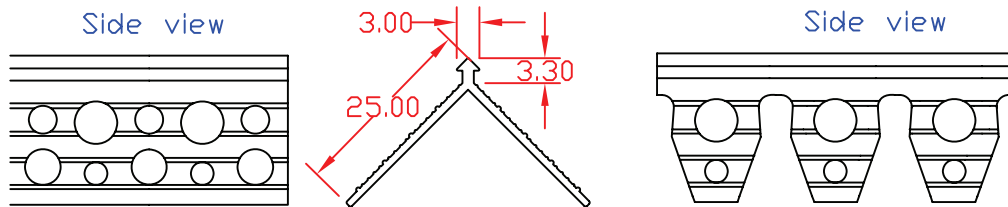

PAL ARCH BEAD
PAL DIE No 5079

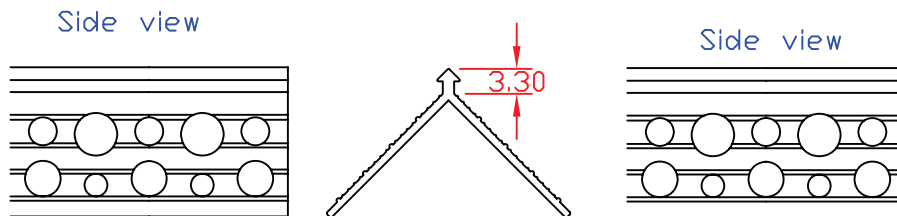

PAL THIN COAT ANGLE BEAD
PAL DIE No 5079

A4

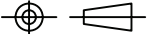
MATERIAL:	COLOUR:	ALL DIMENSIONS IN MM				
		PROJECTION 				
TITLE:	DRAWING No.	ISSUE:	DRAWN:	INITIAL:	DATE:	SCALE:
ARCH & THIN COAT BEAD		1	8/01/09	MR		
PAL EXTRUSIONS DARLASTON ROAD WEDNESBURY WS10 7TN TEL: 0121 526 4048						©

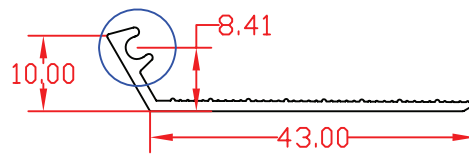

PAL 10mm BELL CAST BEAD
PAL DIE No 5032

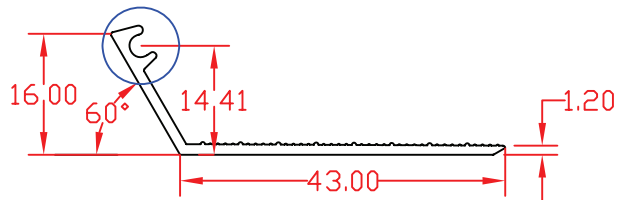

PAL 16mm BELL CAST BEAD
PAL DIE No 5031

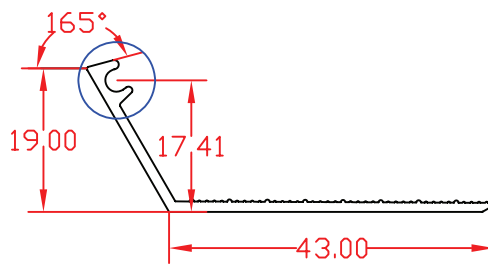

PAL 19mm BELL CAST BEAD
PAL DIE No 5030

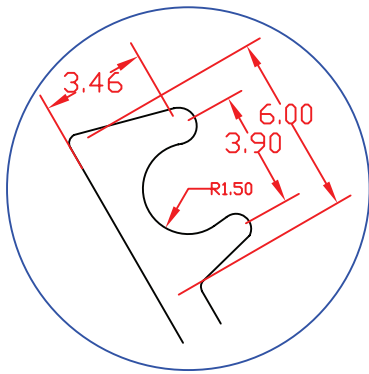

4:1

BOTTOM VIEW

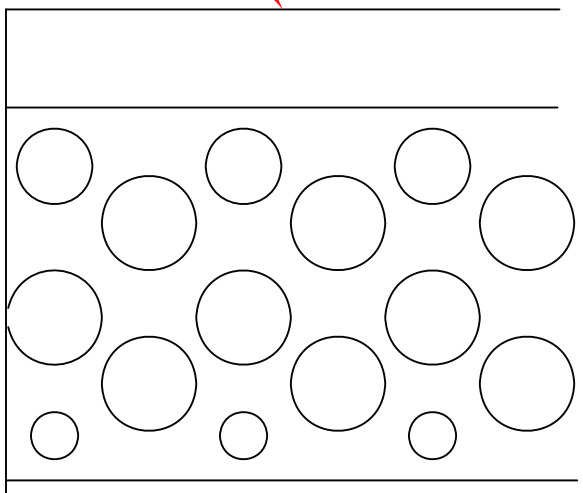

A4

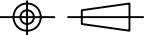
MATERIAL:	COLOUR:	ALL DIMENSIONS IN MM				
		PROJECTION 				
TITLE:	DRAWING No.	ISSUE:	DRAWN:	INITIAL:	DATE:	SCALE:
BELL CAST BEADS		1	8/01/09	MR		
PAL EXTRUSIONS DARLSTON ROAD WEDNESBURY WS10 7TN TEL: 0121 526 4048						©

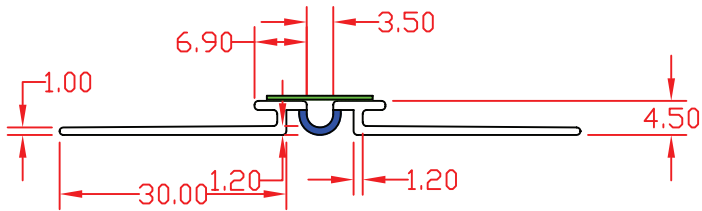

PAL 4.5mm EXPANSION BEAD
PAL DIE No 3442

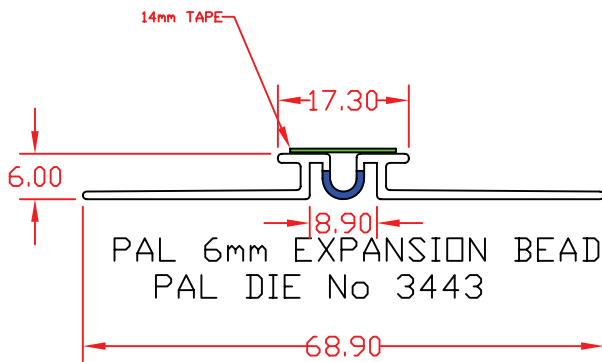

PAL 6mm EXPANSION BEAD
PAL DIE No 3443

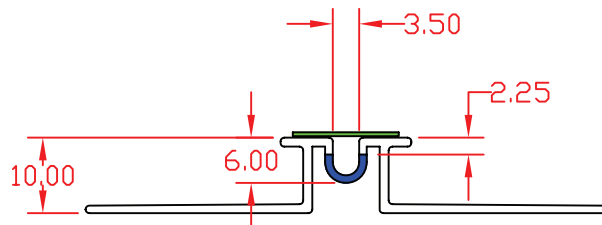

PAL 10mm EXPANSION BEAD
PAL DIE No 3444

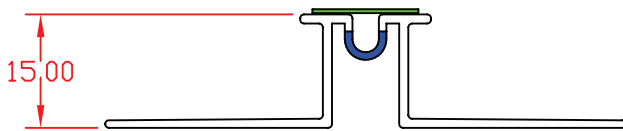

PAL 15mm EXPANSION BEAD
PAL DIE No 3445

TOP VIEW

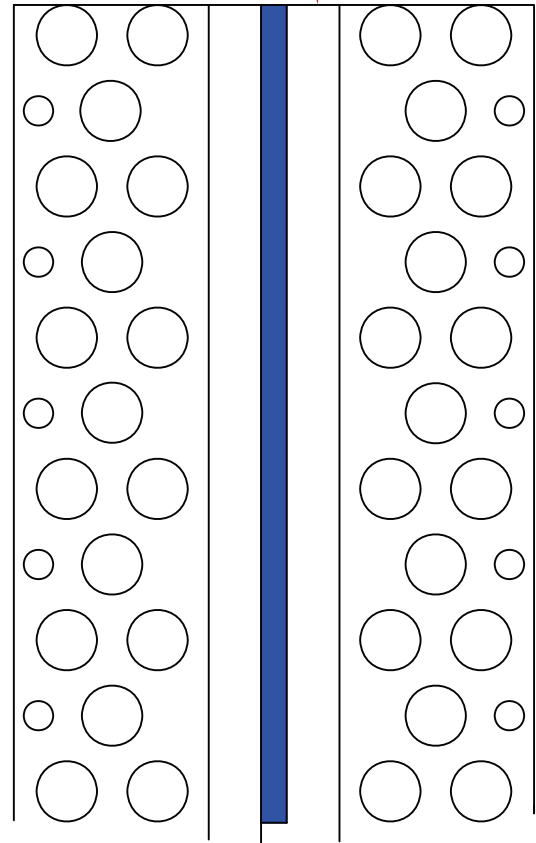

A4

MATERIAL:	COLOUR:	ALL DIMENSIONS IN MM				
TITLE:	DRAWING No.	ISSUE:	DRAWN:	INITIAL:	DATE:	SCALE:
EXPANSION BEADS		1	8/01/09	MR		

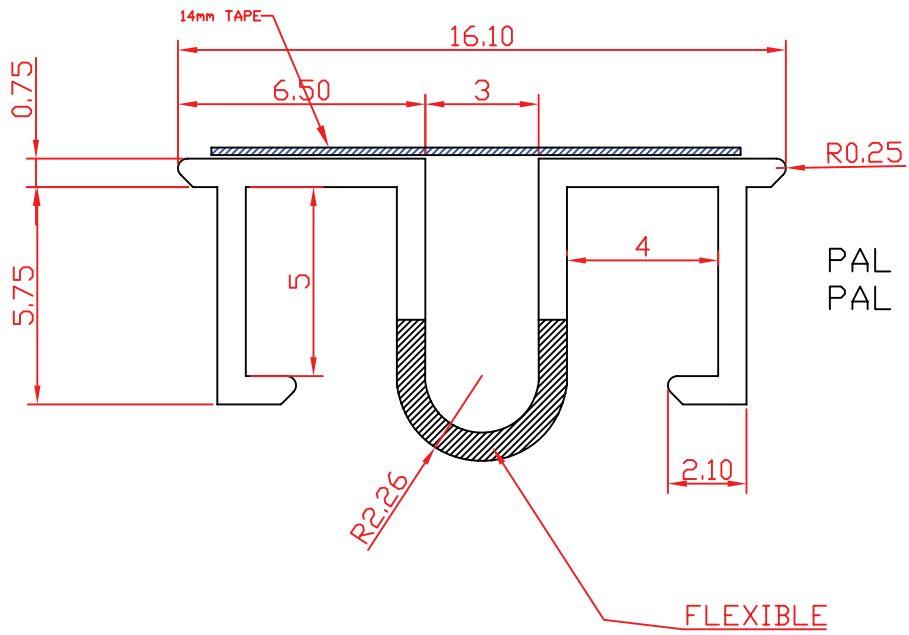

PAL MOVEMENT BEAD
PAL DIE No 3288

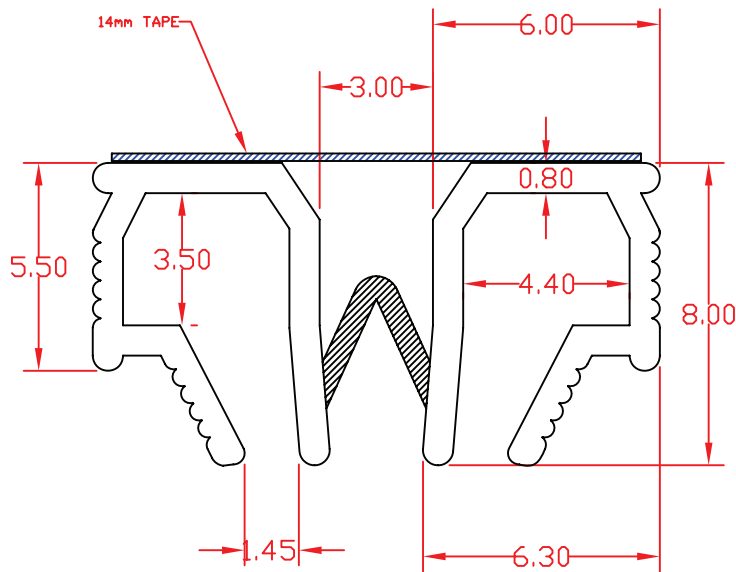

PAL MOVEMENT BEAD
PAL DIE No 3452

A4

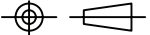
MATERIAL:	COLOUR:	ALL DIMENSIONS IN MM				
		PROJECTION 				
TITLE:	DRAWING No.	ISSUE:	DRAWN:	INITIAL:	DATE:	SCALE:
MOVEMENT BEADS		1	8/01/09	MR		
PAL EXTRUSIONS DARLASTON ROAD WEDNESBURY WS10 7TN TEL: 0121 526 4048						©

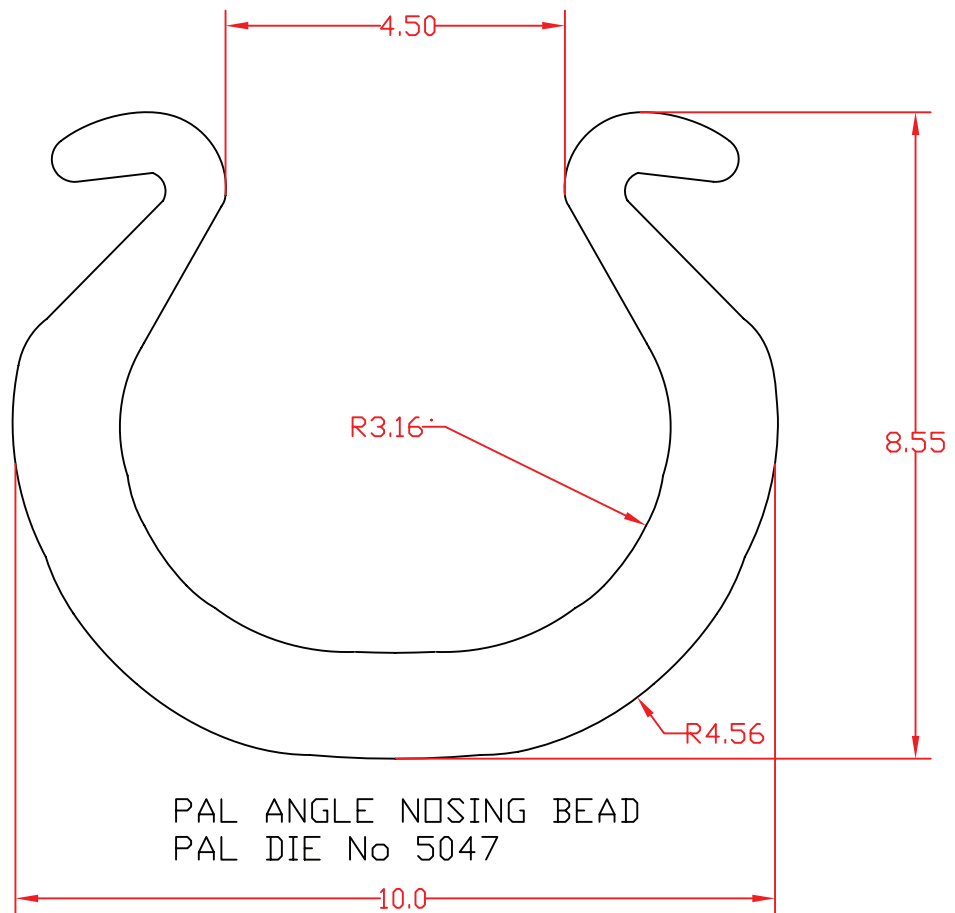
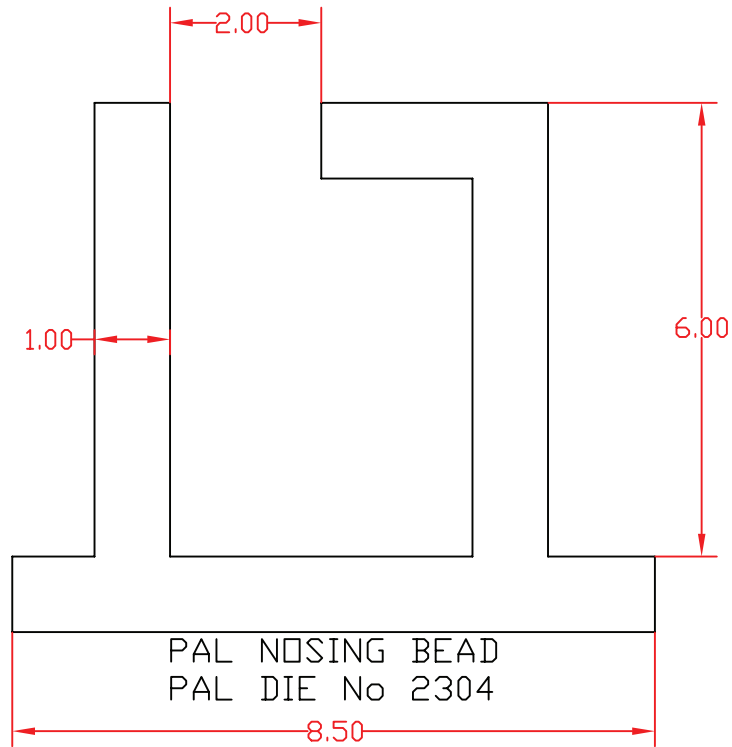

A4

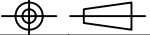
MATERIAL:	COLOUR:	ALL DIMENSIONS IN MM				
		PROJECTION 				
TITLE:	DRAWING No.	ISSUE:	DRAWN:	INITIAL:	DATE:	SCALE:
NOSING BEADS		1	8/01/09	MR		

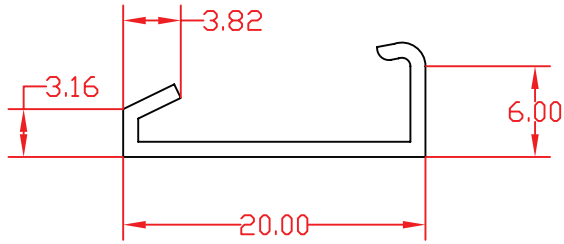

PAL DIE No 2607

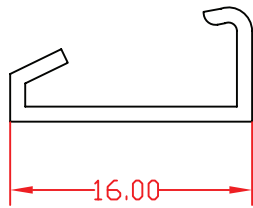

PAL DIE No 2608

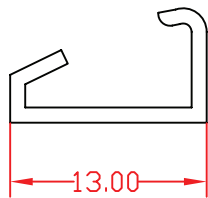

PAL DIE No 2609

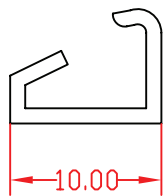

PAL DIE No 2610

A4

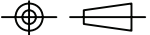
MATERIAL:	COLOUR:	ALL DIMENSIONS IN MM				
		PROJECTION 				
TITLE:	DRAWING No.	ISSUE:	DRAWN:	INITIAL:	DATE:	SCALE:
STEEL, PVC NOSING BEADS		1	8/01/09	MR		
PAL EXTRUSIONS DARLASTON ROAD WEDNESBURY WS10 7TN TEL: 0121 526 4048						©

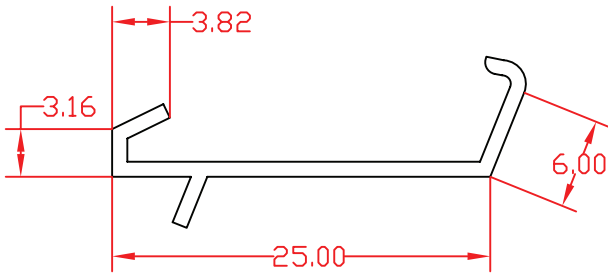

PAL DIE No 2602

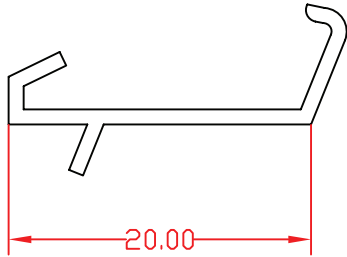

PAL DIE No 2603

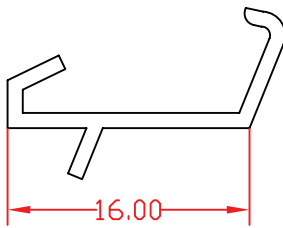

PAL DIE No 2604

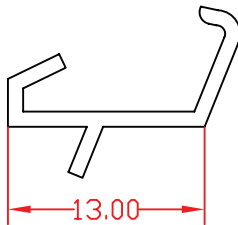

PAL DIE No 2605

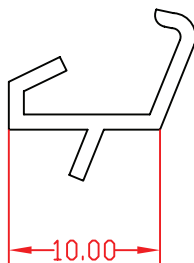

PAL DIE No 2606

A4

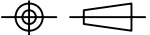
MATERIAL:	COLOUR:	ALL DIMENSIONS IN MM				
		PROJECTION 				
TITLE:	DRAWING No.	ISSUE:	DRAWN:	INITIAL:	DATE:	SCALE:
STEEL, PVC NOSING BEADS		1	8/01/09	MR		
PAL EXTRUSIONS DARLASTON ROAD WEDNESBURY WS10 7TN TEL: 0121 526 4048						©

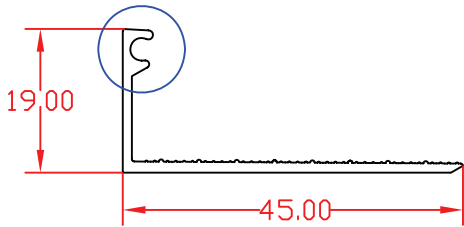

PAL 19mm STOP BEAD
PAL DIE No 5033

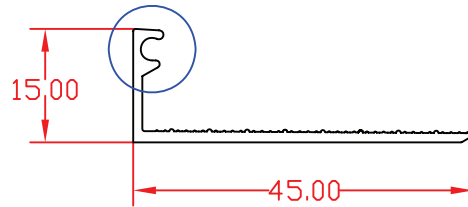

PAL 15mm STOP BEAD
PAL DIE No 5034

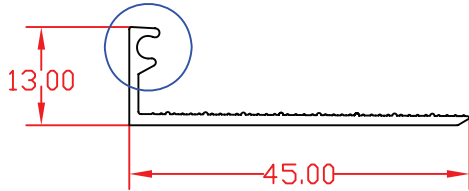

PAL 13mm STOP BEAD
PAL DIE No 5035

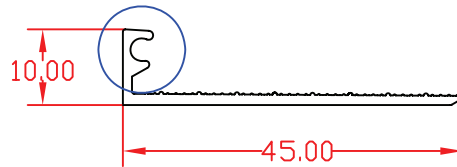

PAL 10mm STOP BEAD
PAL DIE No 5036

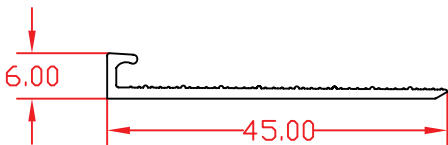

PAL 6mm STOP BEAD
PAL DIE No 5037

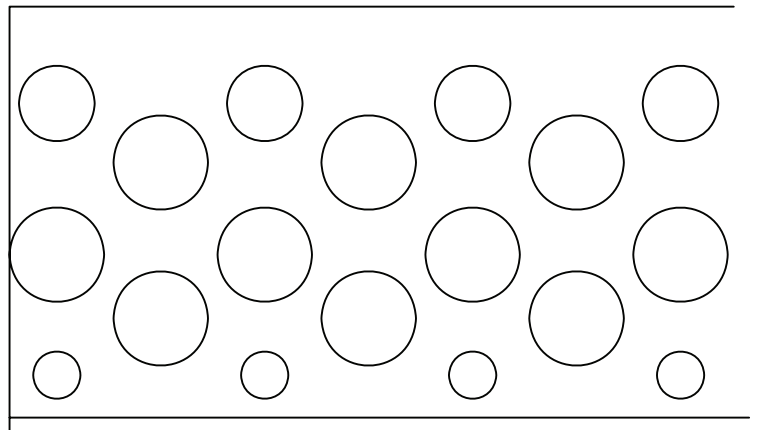

BOTTOM VIEW

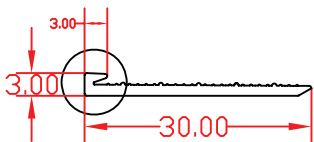

PAL 3mm STOP BEAD
PAL DIE No 5038

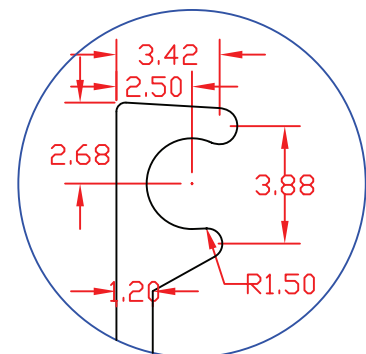
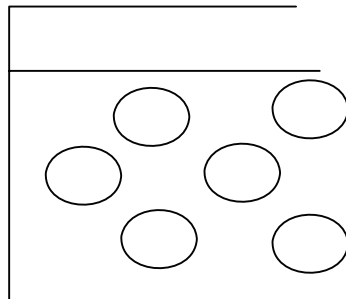

4-1
Detail

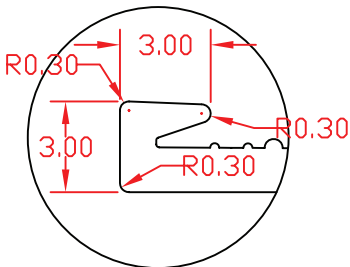

A4

MATERIAL:	COLOUR:	ALL DIMENSIONS IN MM				
		PROJECTION				
TITLE:	DRAWING No.	ISSUE:	DRAWN:	INITIAL:	DATE:	SCALE:
STOP BEADS		1	8/01/09	MR		